

TRAITEMENT DES EAUX USÉES

(RÉSIDENTIELLE ET COMMERCIALE)

- _ FOSSES SEPTIQUES
- _ FOSSES DE RÉTENTION
- _ PUIITS ABSORBANTS

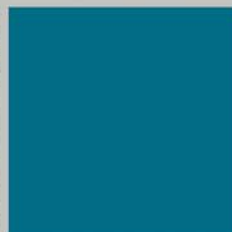
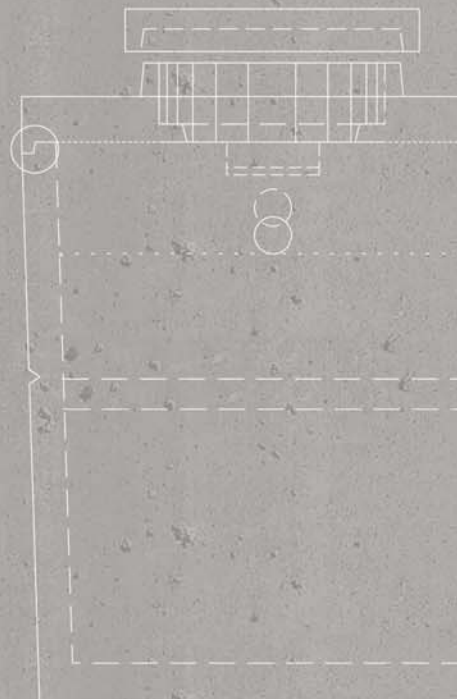

FOSSES SEPTIQUES EN BÉTON ARMÉ 750 @ 1200 gal.

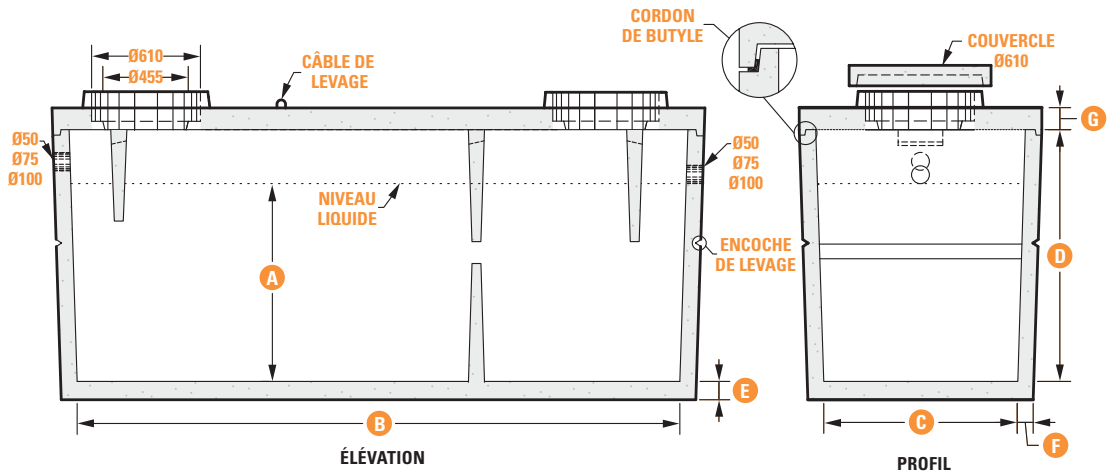

CERTIFIÉES NQ 3680-905

VOLUME NOMINAL (GALLONS)	CAPACITÉ (VOLUME) M ³		A	B	C	D	E	F	G	POIDS (kg) CUVE	POIDS (kg) DALLE
	TOTALE MINIMALE	EFFECTIVE LIQUIDE									
FS0750	3,400	2,714	850	2870	1075	1100	100	75	100	2500	800
FS0850	3,900	3,170	1000	2860	1065	1250	100	75	100	2700	800
FS1050	4,875	3,790	1075	3292	1057	1375	100	90	120	3000	1000

CERTIFIÉE CSA A23.4

FS1200	5,825	4,700	1250	2806	1281	1550	100	100	100	4200	1100
--------	-------	-------	------	------	------	------	-----	-----	-----	------	------

FS0750 @ FS1200 DISPONIBLE AVEC PRÉFILTRE

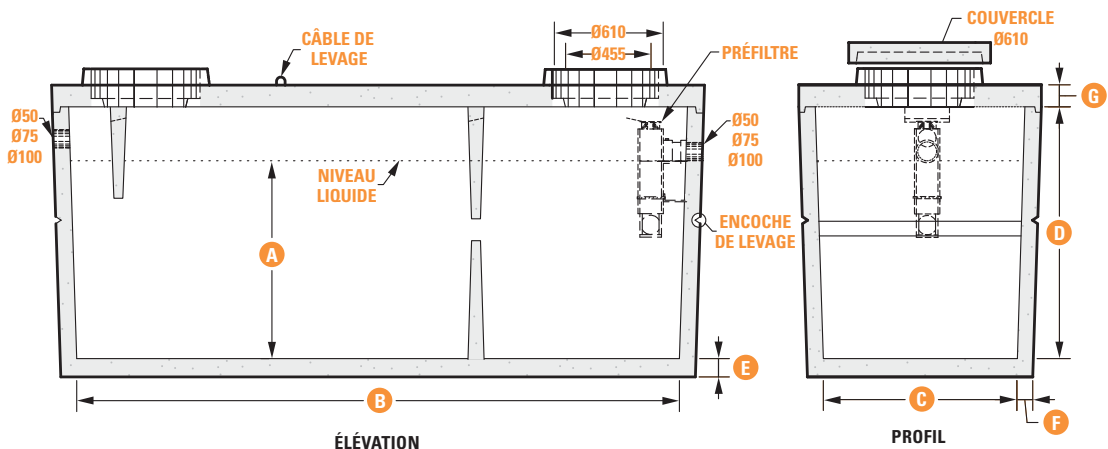

FOSSES SEPTIQUES EN BÉTON ARMÉ 1500 @ 7000 gal.

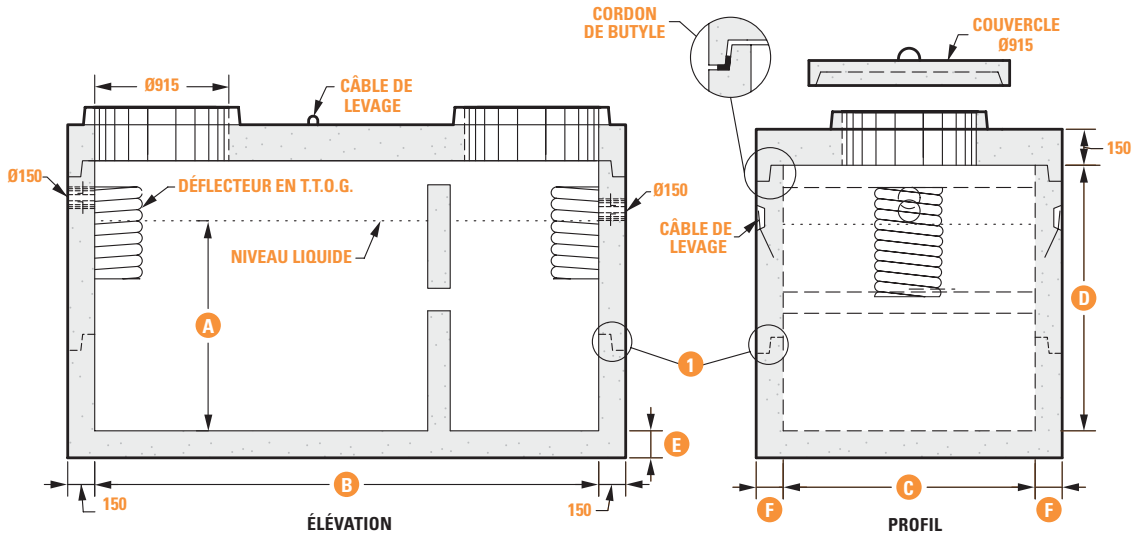

CERTIFIÉES CSA A23.4

VOLUME NOMINAL (GALLONS)	CAPACITÉ (VOLUME) M ³		A	B	C	D	E	F	POIDS (kg) CUVE	POIDS (kg) EXTENSION	POIDS (kg) DALLE
	TOTALE MINIMALE	EFFECTIVE LIQUIDE									
FS1500	6,960	5,160	1075	3200	1500	1450	150	150	7590	---	2150
FS1800	8,415	6,500	1275	3400	1500	1650	150	150	8725	---	2270
FS2000	9,188	7,220	1375	3500	1500	1750	150	150	9350	---	2330
FS2500	11,664	9,234	1425	3600	1800	1800	150	150	10600	---	2900
FS3000	13,680	10,830	1425	3800	2000	1800	150	150	11685	---	3300
FS3500	16,200	12,825	1425	4500	2000	1800	150	200	15150	---	4000
FS4000	18,522	14,663	1425	4900	2100	1800	150	200	16480	---	4500
FS4500	20,790	16,460	1425	5500	2100	1800	150	200	18130	---	5100
FS5000	22,896	18,126	1425	5300	2400	1800	150	200	18700	---	5475
FS5500	25,056	19,836	1425	5800	2400	900+900	200	200	14960	7310	6015
FS6000	27,648	21,888	1425	6400	2400	900+900	200	200	16315	7920	6600
FS6500	29,808	23,598	1425	6900	2400	600+1200	200	200	14750	11500	7040
FS7000	31,968	25,308	1425	7400	2400	600+1200	200	250	16980	13990	7900

* Toutes les dimensions sont en millimètres

1 Emboîtements pour les modèles FS5500 @ FS7000 inclusivement



BUREAU DES VENTES
MATANE (418) 562.0074
(418) 562.0081

BUREAU DES VENTES
QUÉBEC (418) 627.7242
(418) 627.9168

www.betonprovincial.com

FOSSES DE RÉTENTION EN BÉTON ARMÉ 750 @ 1200 gal.

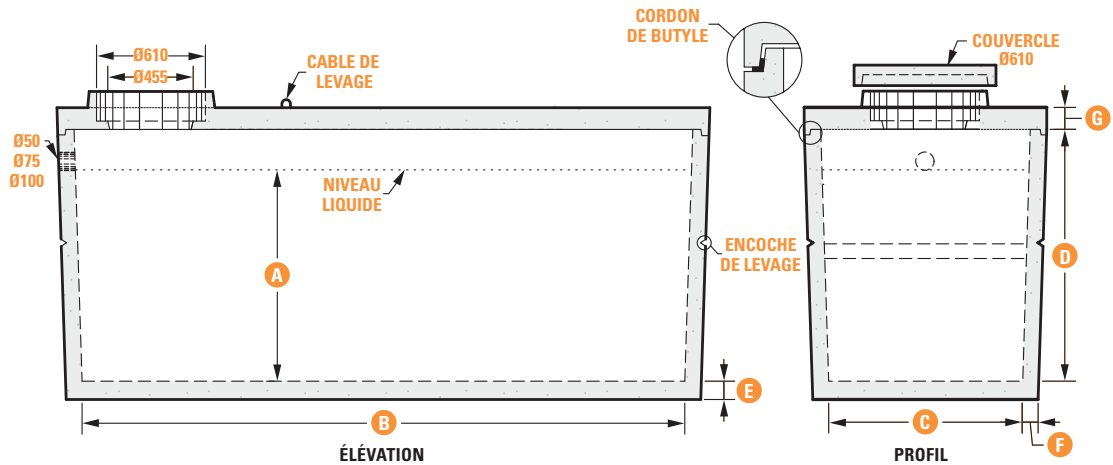

CERTIFIÉES NQ 3682-901

VOLUME NOMINAL (GALLONS)	CAPACITÉ (VOLUME) M ³		A	B	C	D	E	F	G	POIDS (kg) CUVE	POIDS (kg) DALLE
	TOTALE MINIMALE	EFFECTIVE LIQUIDE									
FR0750	3,400	2,737	925	2870	1075	1100	100	75	100	2500	800
FR0850	3,900	3,200	1075	2860	1065	1250	100	75	100	2700	800
FR1050	4,875	3,790	1150	3292	1057	1375	100	90	120	3000	1000

CERTIFIÉE CSA A23.4

FR1200	5,825	4,700	1325	2806	1281	1550	100	100	100	4200	1100
--------	-------	-------	------	------	------	------	-----	-----	-----	------	------

* Toutes les dimensions sont en millimètres

FOSSES DE RÉTENTION EN BÉTON ARMÉ 1500 @ 7000 gal.

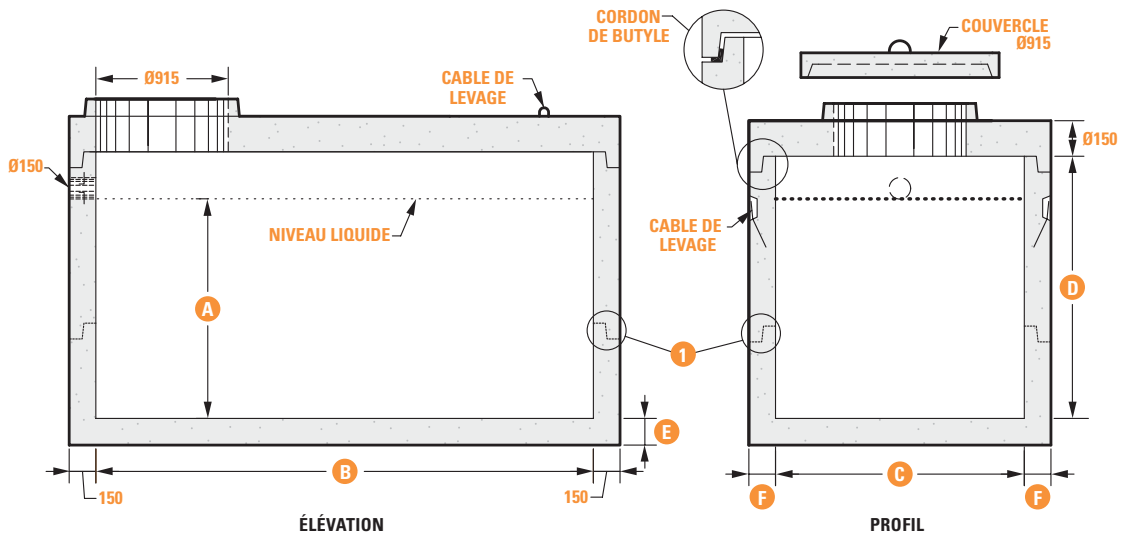

CERTIFIÉES CSA A23.4

VOLUME NOMINAL (GALLONS)	CAPACITÉ (VOLUME) M ³		A	B	C	D	E	F	POIDS (kg) CUVE	POIDS (kg) EXTENSION	POIDS (kg) DALLE
	TOTALE MINIMALE	EFFECTIVE LIQUIDE									
FR1500	6,960	5,196	1150	3200	1500	1450	150	150	7590	---	2150
FR1800	8,415	6,539	1350	3400	1500	1650	150	150	8725	---	2270
FR2000	9,188	7,260	1450	3500	1500	1750	150	150	9350	---	2330
FR2500	11,664	9,283	1500	3600	1800	1800	150	150	10600	---	2900
FR3000	13,680	10,887	1500	3800	2000	1800	150	150	11685	---	3300
FR3500	16,200	12,893	1500	4500	2000	1800	150	200	15150	---	4000
FR4000	18,522	14,741	1500	4900	2100	1800	150	200	16480	---	4500
FR4500	20,790	16,547	1500	5500	2100	1800	150	200	18130	---	5100
FR5000	22,896	18,238	1500	5300	2400	1800	150	200	18700	---	5475
FR5500	25,056	19,940	1500	5800	2400	900+900	200	200	14960	7310	6015
FR6000	27,648	22,003	1500	6400	2400	900+900	200	200	16315	7920	6600
FR6500	29,808	23,722	1500	6900	2400	600+1200	200	200	14750	11500	7040
FR7000	31,968	25,441	1500	7400	2400	600+1200	200	250	16980	13990	7900

1 Emboîtements pour les modèles FR5500 @ FR7000 inclusivement

PUITS ABSORBANT EN BÉTON ARMÉ

- + Certifié NQ 3682-850
- + Surface d'absorption : 20 m²

